



Committing to the future

Compressed air meter 0699 6445

For diameters DN50 (2") to DN300 (12")



99 Washington Street
Melrose, MA 02176
Phone 781-665-1400
Toll Free 1-800-517-8431

 Visit us at www.TestEquipmentDepot.com



Nm/s

Nm³/h

NI/min

Compressed air meter

Application

Why does industry need compressed air meters?

Media such as current, water and gas have complete transparency in every industrial company: main meters reflect the quantities used, while decentralised meters show how consumption is distributed.

Compressed air, on the other hand, is generated internally and distributed without it being known as to how much is consumed in total and in individual areas. Without having this knowledge, however, there is no motivation to repair leaks or to aim for more economical consumption.

In addition, compressed air meters offer the possibility of continuous monitoring for leakage, which accounts for approx. 35 percent of all compressed air consumption.

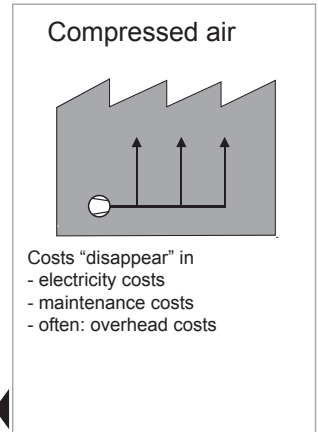
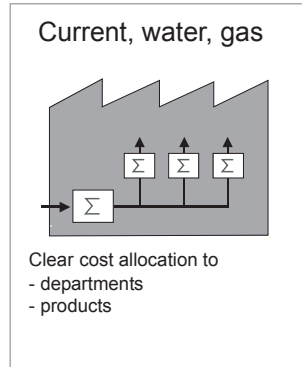

Compressed air:
"creeping assets consumer"

Features

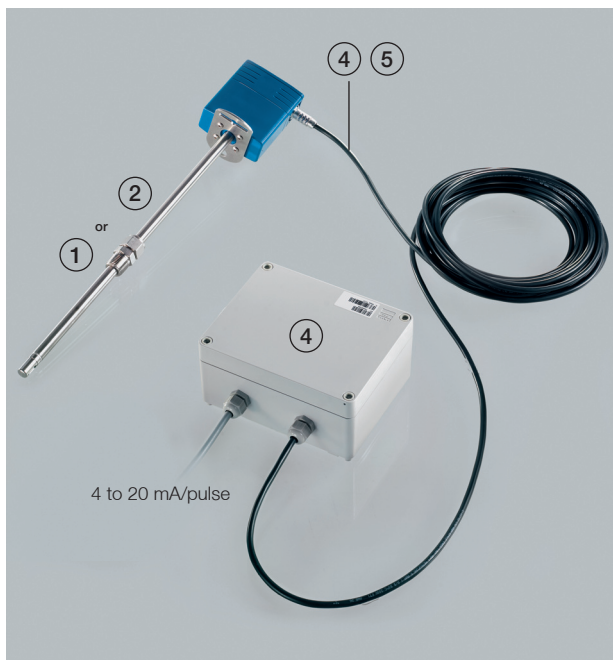

- ① 0699 6445/1 (standard compressed air meter)
- ② 0699 6445/2 (up to 150 Nm/s)
- ③ 0699 6445/3 (display, optional)
 - Totaliser function (sum display)
 - Speed or volume flow rate display
 - Physical units selectable via software
- ④ 0699 6445/4 (distributor box, cable and software)
 - IP 65 distributor box, wall mounting possible
 - RS-232 jack for programming
 - CD with programming software
 - Two cable entries + signal cable (10 m)
 - Internal screw connectors
- ⑤ 0699 6445/5 (10 m cable)

- All relevant signal outputs on board
- Analog output 4 to 20 mA (4-wire)= normalized flow velocity value or normalized volume flow value
 - Pulse output (consumption)
 - Voltage supply 12 to 24 VDC
 - RS232 output for parameterisation
 - 5-point calibration certificate included (standard)

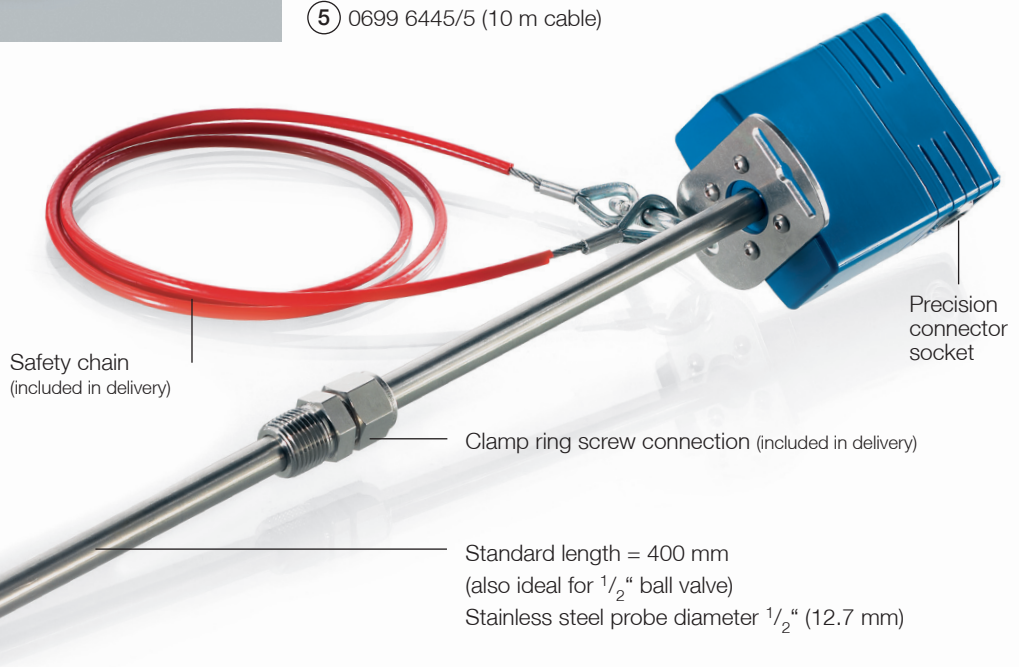
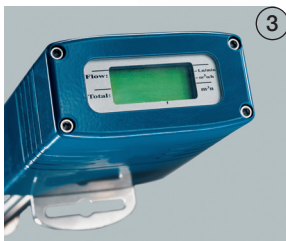

Robust, thermal silicon chip sensor (mass flow principle)

Selecting a compressed air meter

1

· What is the maximum nominal volume flow rate in your process?

2

· Select appropriate compressed air meter

① 0699 6445/1
4 mA = 0 Nm/s,
20 mA = 80 Nm/s

② 0699 6445/2
4 mA = 0 Nm/s,
20 mA = 150 Nm/s

Example

At 1000 Nm³/h and with a nominal pipe diameter of DN150, the flow rate is approx. 15 Nm/s.

Here, the standard version 0699 6445/1 (up to 80 Nm/s) can be used. Select model 0699 6445/2 between 80 and 150 Nm/s.

Caution!

In calculating, the respective nominal diameter was used as the internal diameter

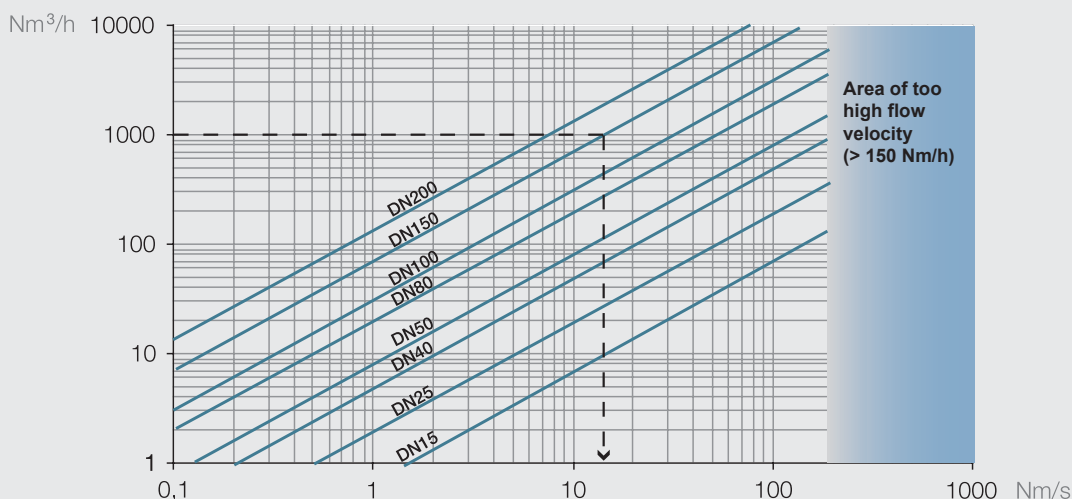

Mechanical assembly

(Observe the operating instructions!

These are only brief schematic instructions)

1. Observe straight pipe lengths for upstream/downstream obstacles 20x DN (upstream), 5x DN (downstream)
2. Any desired installation position allowed; min. 2 Nm/s with vertical pipes
3. De-pressurise pipe
4. Install the 1/2" clamp ring screw-connection or a 1/2" ball valve
5. Measure the pipe internal diameter for conversion later on: $\text{flow rate [Nm/s]} \times \frac{\pi}{4} \times (\text{internal diameter})^2 = \text{volume flow rate}$
6. Guide in probe up to the middle of the pipe (if possible)
7. Align exactly; observe volume flow direction arrow
8. Safeguard with clamp screw connection and safety chain

Dimensions

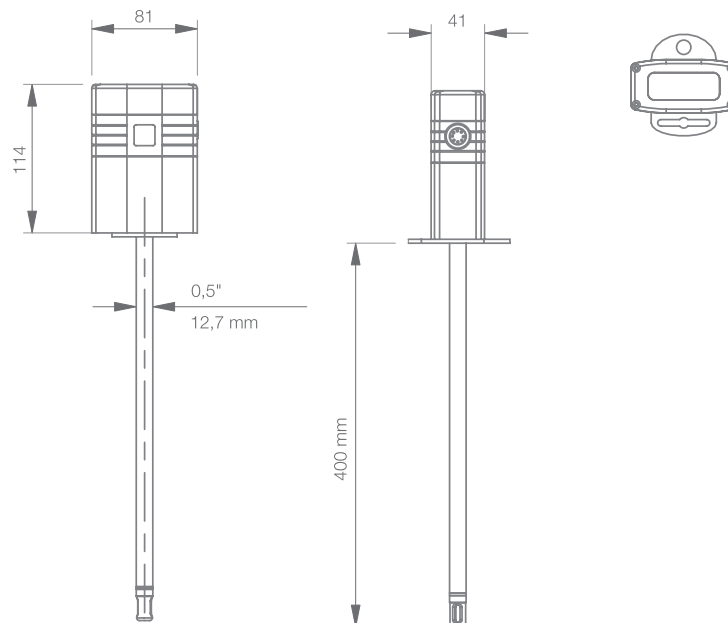

Electrical connection

Illustration of socket assignment on instrument (precision connector socket)

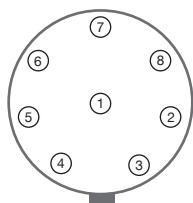

Signal	Wire colour	Colour	Contact
0 Volt	Brown		2
+ 12 to 24 Volt	Red		8
RX	White		1
TX	Green		3
4 to 20 mA -	Blue		7
4 to 20 mA +	Yellow		4
Pulse +	Orange		6
Pulse -	Grey		5
Shield	-		x

Compressed air meter

Technical data	
Sensors	Thermal silicon chip sensor, mass flow principle
Media	Compressed air, air, nitrogen, non-corrosive gases (attention: not approved for use in explosive areas)
Display	Optional, order no. 0699 6445/3, two-line
Measuring range	0 to 80 Nm/s, min. 1 Nm/s (0699 6445/1) or 0 to 150 Nm/s, min. 2 Nm/s (0699 6445/2)
Accuracy	+/- 3 % of reading +/- 0.4 % of final value
Pressure dependence	Measuring principle independent of pressure (mass flow measurement). For flow rates < 10 Nm/s: pressure influence 0.3 % of reading per bar
Temperature dependence	Compensated at 25 °C, deviating temperatures: 0.1 % of reading/Kelvin
Response time	t90 approx. 5 seconds
Voltage supply	12 to 24 V DC +/- 10 %, power consumption < 100 mA (starting current briefly 500 mA)
Electrical connection	Precision plug connection for distributor box, 0699 6445/4 or for cable 0699 6445/5
Analog output	4 to 20 mA = 0 to 80 or 0 to 150 Nm/s, 4-wire, max. load = 500 Ohm, max. length 250 m (use shielded cable!)
Pulse output	Floating contact, 12 to 24 V DC switching voltage from external meter, corresponding to S0 meter signal (DIN 43864). Pulse as a function of the adjusted internal diameter
Digital output	RS232, max. cable length 15 meters, easily accessible in conjunction with distributor box 0699 6445/4
Process conditions	+50 °C (ideal at 20 to 30 °C), PN 16 (max. 16 bar), rel. humidity < 90 % RH (no remaining effect after re-drying), air quality (ISO 8573: Classes 1/4/1)
Ambient temperature	-10 to +60 °C
Storage temperature	-40 to +80 °C. Avoid ice build-up
Normalization reference	Standard flow rate (e.g. Nm/s) and normalized volume flow rate (e.g. Nm/s) are in reference to 15 °C, 1013.25 mbar, 0 % RH (DIN ISO 2533)
Weight	Compressed air meter: 840 g, display: 140 g, 10 meter cable: 640 g, clamping screw connection: 100 g
Housing	Aluminium, enamelled. IP 65, however only permitted for use in indoor installations
EMC	EN 50082-1

Ordering data

Compressed air meter	Order no.
① Compressed air meter to 80 Nm/s (for features, see graphic at bottom of page 2)	0699 6445/1
② Compressed air meter to 150 Nm/s (for features, see graphic at bottom of page 2)	0699 6445/2

Accessories	Order no.
③ Display with sum indicator (directly on compressed air meter) order together with ① or ②	0699 6445/3
④ Distributor box for programming (via RS-232), with software CD and 10 m cable	0699 6445/4
⑤ 10 m cable with precision plug connection (on device)	0699 6445/5
⑥ Parameterisation in factory, according to the adjusted inner diameter	0699 6445/6
Process display, testo 54-2AC, 2 relay outputs (to 250 V AC/ open wire ends)	5400 7553
Process display, testo 54-7AC, 2 relay outputs (to 250 V AC/ 300 V DC, 3A), power supply 90..260 V AC, with RS-485 output to online monitoring and with totaliser display	5400 7555
Mains unit (desktop unit) 100 to 240 V AC/24 V DC (350 mA)	0554 1748
Mains unit (DIN rail mounting) 90 to 264 V AC/24 V DC (3 A)	0554 1749
ISO calibration at 5 measurement points, to 250 Nm ³ /h	0520 0174
DKD calibration at 5 measurement points, to 250 Nm ³ /h	0520 0274
ISO calibration at 5 measurement points, to 1600 Nm ³ /h	0520 0184
DKD calibration at 5 measurement points, to 1600 Nm ³ /h	0520 0284

Additional options (upon request)

Calibration in industrial gases (e.g. CO ₂ , argon, nitrogen etc.)
Version for low flow rate (max. 20 Nm/s) or higher pressures (>16 bar)
Probe lengths 300 or 600 mm
Cable entry instead of precision connector at compressed air meter

Accessories selection aid

Customer request	Products 0699 6445/...									
	①	②	③	④	⑤	⑥	⑦	⑧	⑨	⑩
0 to 80 Nm/s	●	●	●				●	●		
0 to 150 Nm/s				●	●	●			●	●
without display	●		●	●		●		●		●
with display		●			●		●		●	
4 to 20 mA = flow rate (Nm/s)	●	●	●	●	●	●	●	●	●	●
4 to 20 mA = standard volume flow rate (Nm ³ /h)		●	●		●	●	●	●	●	●
Pulse output for ext. meter		●	●		●	●	●	●	●	●
Customer-perf. parameterisation		●	●		●	●				
Parameterisation in factory							●	●	●	●

- Example order:
Compressed air meter 0 to 150 Nm/s with display; one analog output with parameters current or consumption; pulse output for external meter; customer-performed parameterisation.
Order no.: 0699 6445/2 + 0699 6445/3 + 0699 6445/4
- One analog output; both values can be shown on display.
- 0699 6445/4 in addition: if the customer himself wants to perform a totaliser reset or enter the correct internal diameter